

# 8 Inch Face Card Access Control

**DCN-RA08**

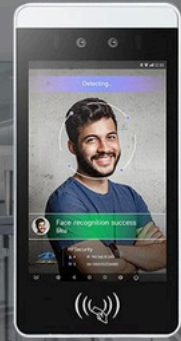

**DCN-RA08**



Card



Facial Recognition



Palm Vein  
(Optional)



QR Code Scan  
(Optional)



Fingerprint Recognition  
(Optional)



Android 11 OS

**DCN-RA08** is DCNSecurity newest 8-inch dynamic dual face live scan time attendance access control with Android 11OS, Ethernet and WIFI connection. Support optional fingerprint, palm vein, and QR code.

## Specification

Operating System	Android 11
Display	8" Full view angle IPS LCD touch screen
Screen Resolution	1280*800 HD display
Dimension	373.7 (L) *133 (W) *85.7 (H) mm
Weight	3KG(Device Only)
Operating Temperature	-10°C ~ 60°C
Working Humidity	10% to 90%
Power Supply	DC12V(±10%)
Power Consumption	10W MAX
Installation Method	Turnstile, Wall mounted, Desktop, Floor Type

## Hardware

CPU	Quad core, 1.8GHz
RAM	2GB
ROM	16GB
Filling Light	LED filling light
Communication	Support Wi-Fi, Bluetooth

## Face Recognition Camera

Dual Camera	2.0MP RGB camera; 1.3MP Infrared camera
Camera Type	Wide dynamic camera
Aperture	4mm
Focal Length	0-2m
White Balance	Automatic
Wide	Automatic
Dynamic	

## Face Recognition Function

Facial Data Capacity	50,000 face data
1:N Face Recognition	99.99%
Stranger Detection	Support
Recognize Distance	Support (0.5m~4m)

## Specification

Serial Communication Interface	RS232
Relay Output	NC,NO and COM
Wiegand Interface	Support Wiegand 26/34 input/output
Reset Button	Yes
Interface	USB2.0, RJ45

## Optional Function

HDMI Interface	Optional HDMI interface
4G Module	Optional 4G module
RFID Reader	Optional IC card reader / HID card reader
Fingerprint Module	Optional FBI certified FAP10 capacitive fingerprint sensor
QR Code	Support
Palm Vein	Support
POE	Support

## Function Introduction

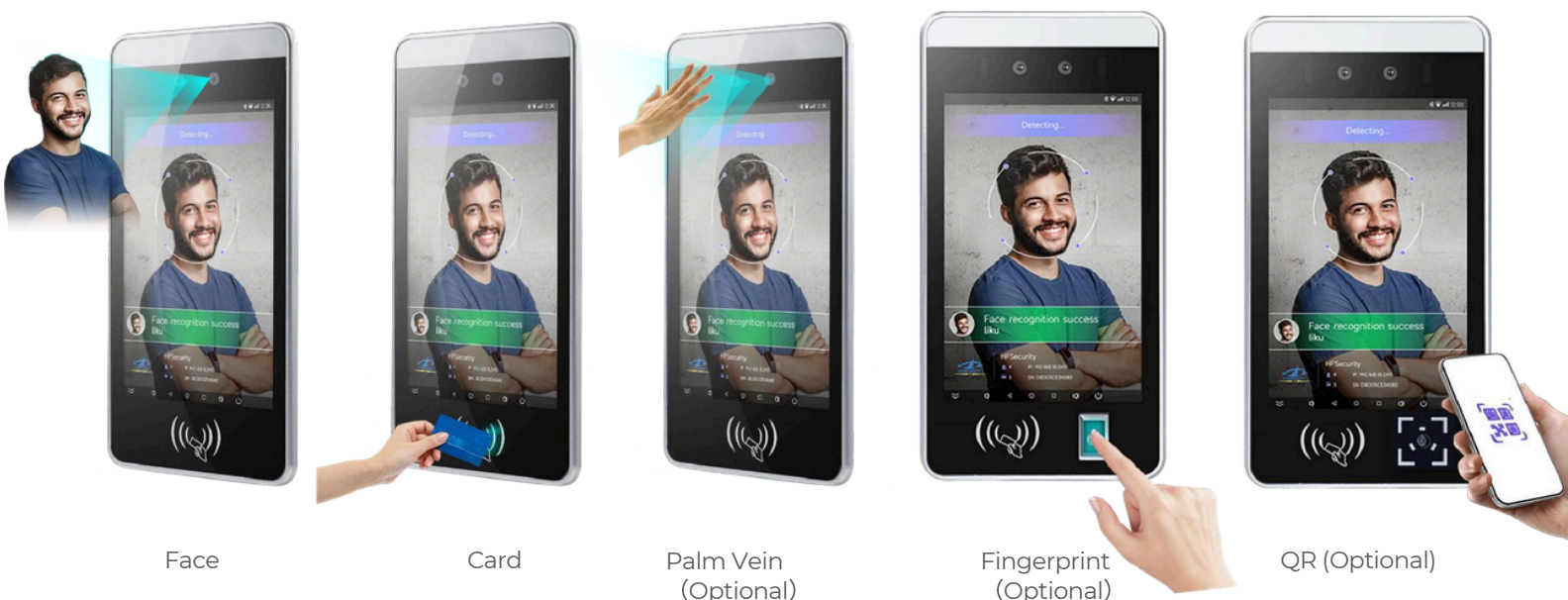



Turnstile type



Floor stand



Adjustable stand



Desktop type



Wall mounted

## Connector Description

GA Version

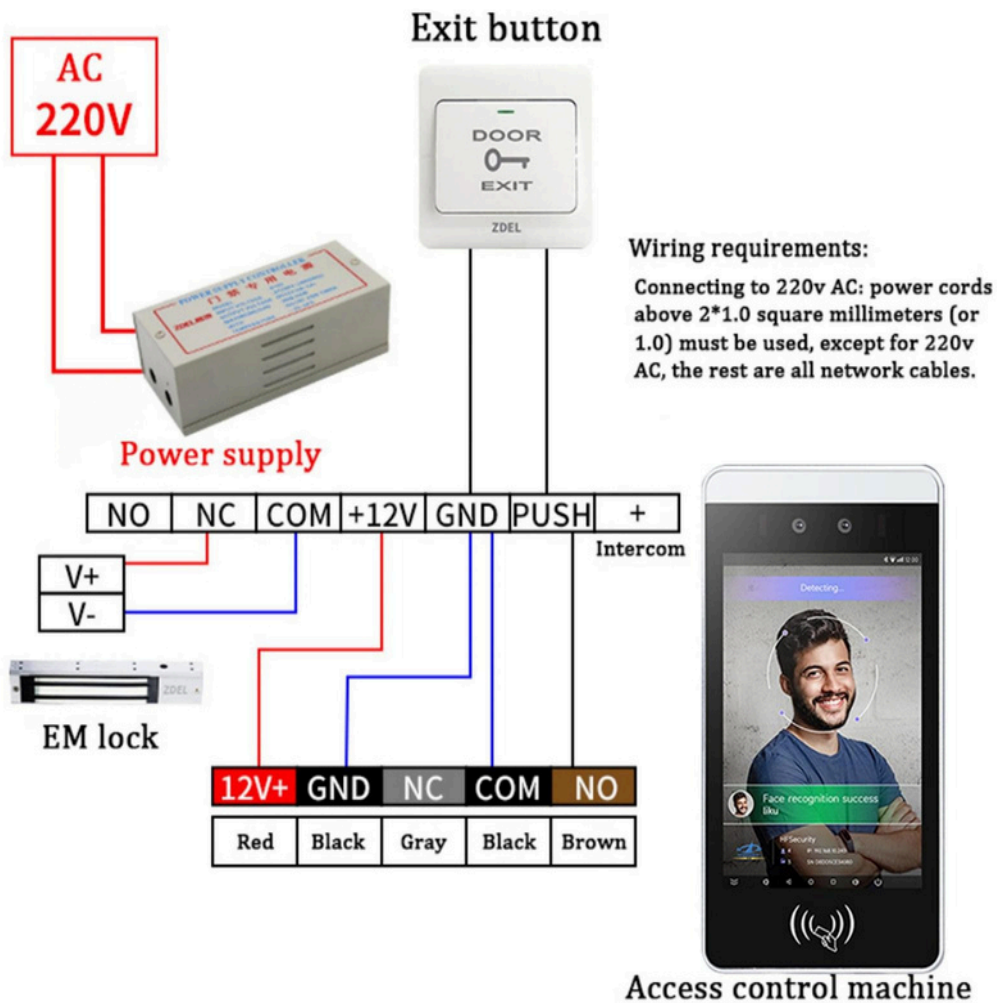
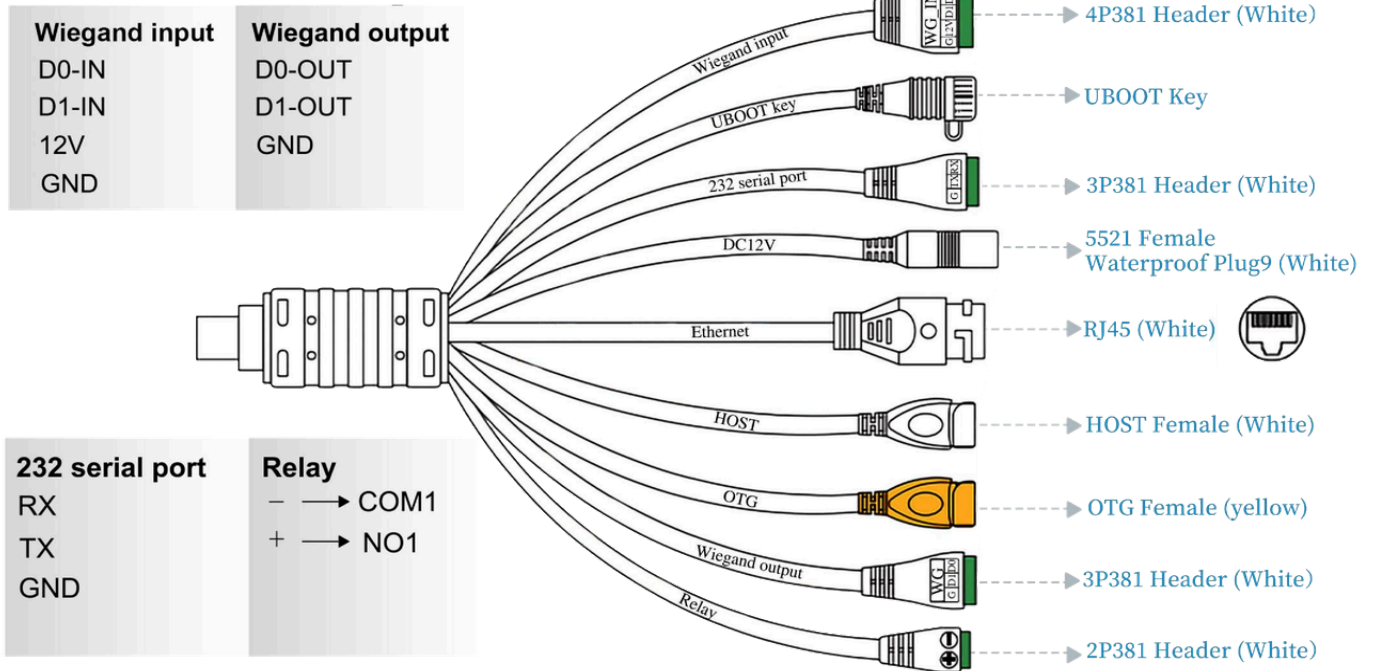

## Even One Sample You Can Get

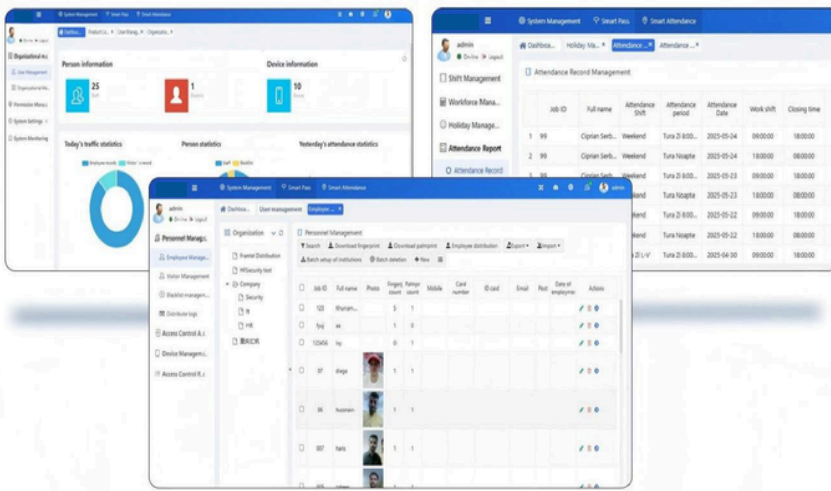

Free Cloud Software



Free API Service



Overall DCNIMS Solution



Register once, use anywhere



- Employee Management
- Visitor Management
- Blacklist Management
- Attendance Record
- Passage Records
- Capture Records
- Attendance Settings
- Ad Settings



## Connect with Turnstile Gate



DCNIMS

More turnstiles you can choose

Entrance Control



# Remote Attendance Solution

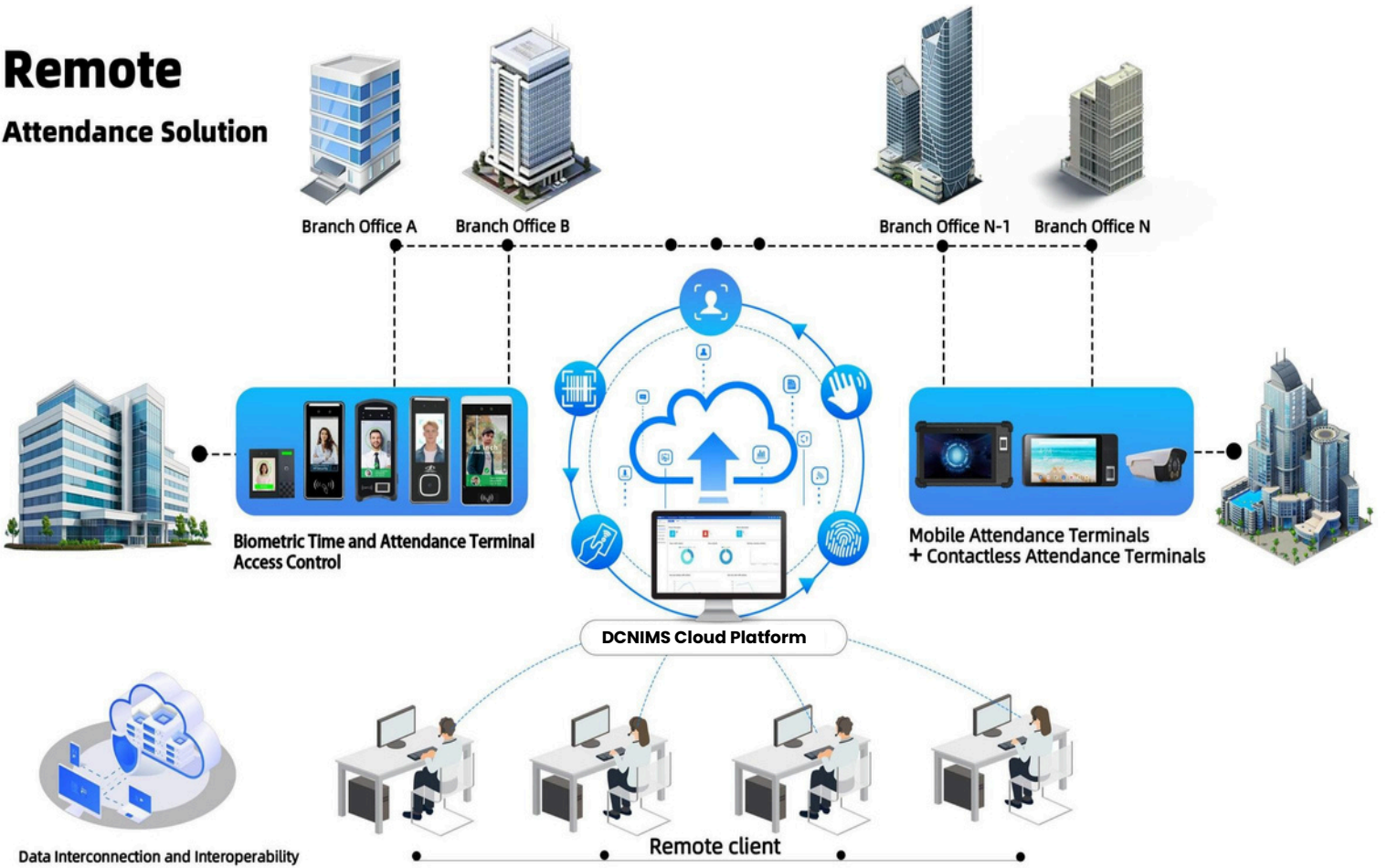

**Multi-device connectivity Cross-regional management**

Multiple attendance machines interconnected, data centrally managed by headquarters, remote administration of attendance terminals, multi-site data, real-time sharing: **multi-location, multi-store, remote site, location-based attendance management.**

With DCNIMS Cloud Platform

Register Once, Use Anywhere

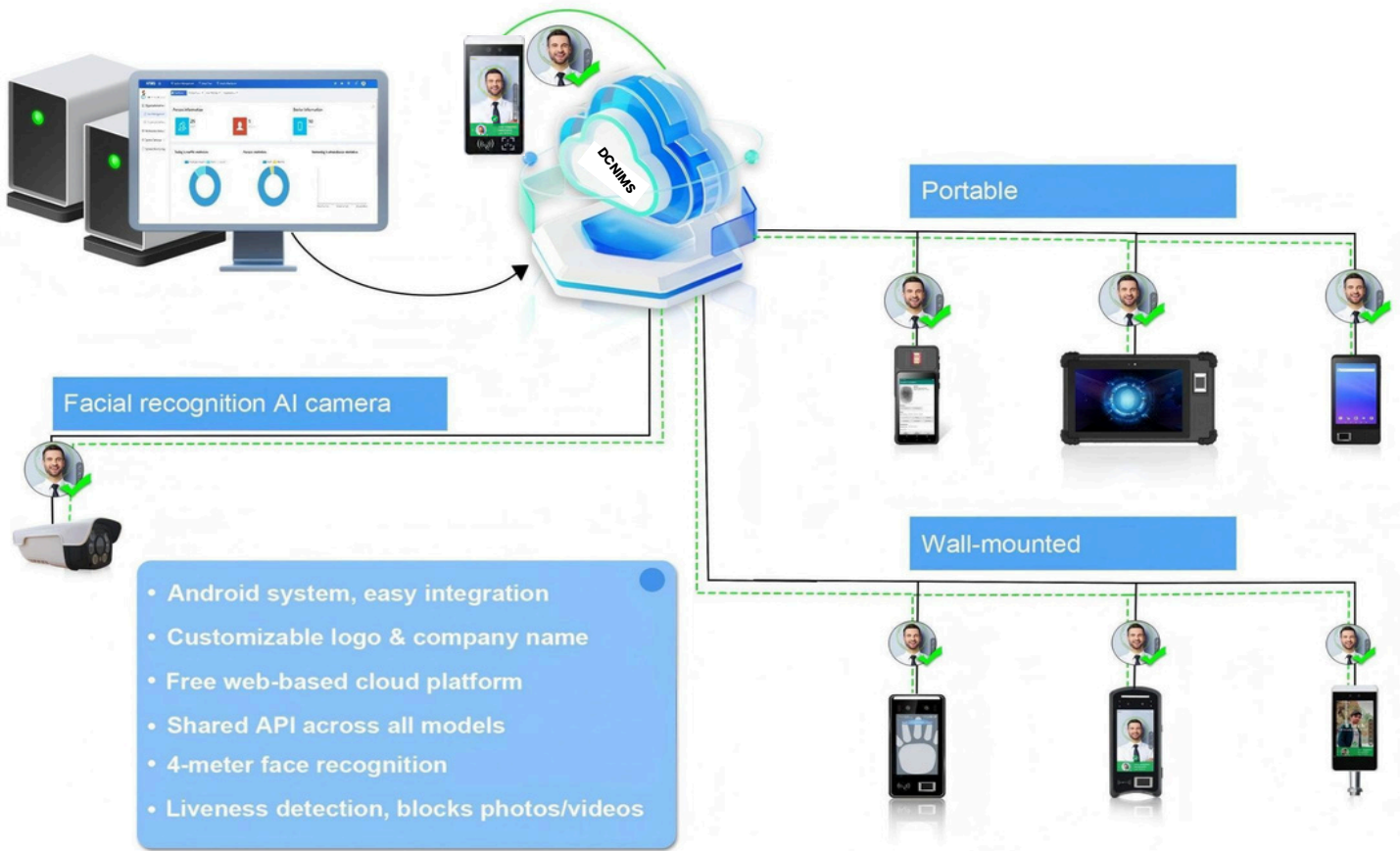

Other Devices You Can Choose

# FACE RECOGNITION SERIES



# Gym Solution

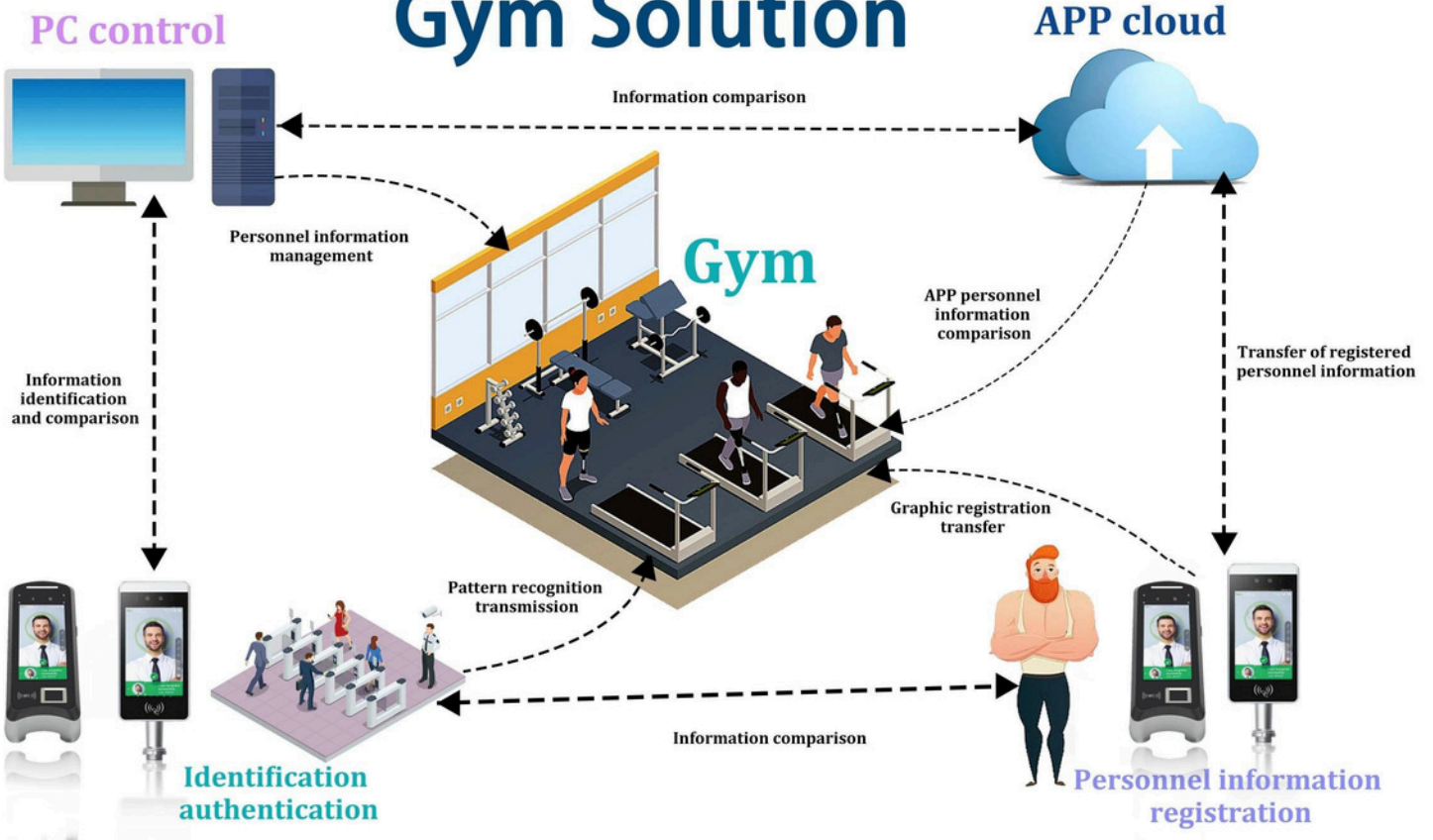

## TA & AC Solution

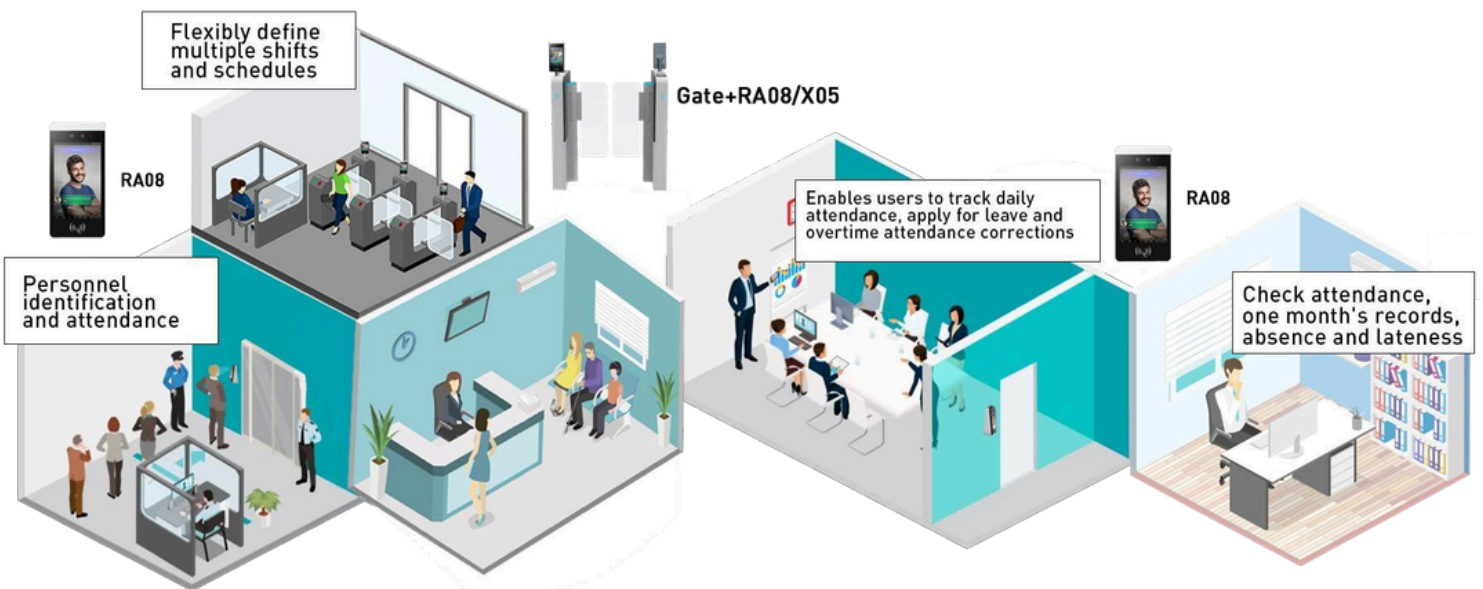

All-in-one Cloud Platform

