

8 Inch Face Card Access Control

DCN-RA08

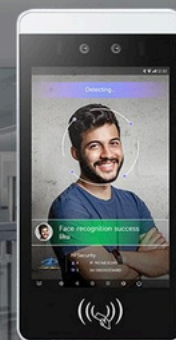

DCN-RA08



Card



Facial Recognition



Palm Vein
(Optional)



QR Code Scan
(Optional)



Fingerprint Recognition
(Optional)



Android 11 OS

DCN-RA08 is DCNSecurity newest 8-inch dynamic dual face live scan time attendance access control with Android 11OS, Ethernet and WIFI connection. Support optional fingerprint, palm vein, and QR code.

Specification

Operating System	Android 11
Display	8" Full view angle IPS LCD touch screen
Screen Resolution	1280*800 HD display
Dimension	373.7 (L) *133 (W) *85.7 (H) mm
Weight	3KG(Device Only)
Operating Temperature	-10°C ~ 60°C
Working Humidity	10% to 90%
Power Supply	DC12V(±10%)
Power Consumption	10W MAX
Installation Method	Turnstile, Wall mounted, Desktop, Floor Type

Hardware

CPU	Quad core, 1.8GHz
RAM	2GB
ROM	16GB
Filling Light	LED filling light
Communication	Support Wi-Fi, Bluetooth

Face Recognition Camera

Dual Camera	2.0MP RGB camera; 1.3MP Infrared camera
Camera Type	Wide dynamic camera
Aperture	4mm
Focal Length	0-2m
White Balance	Automatic
Wide	Automatic
Dynamic	

Face Recognition Function

Facial Data Capacity	50,000 face data
1:N Face Recognition	99.99%
Stranger Detection	Support
Recognize Distance	Support (0.5m~4m)

Specification

Serial Communication Interface	RS232
Relay Output	NC,NO and COM
Wiegand Interface	Support Wiegand 26/34 input/output
Reset Button	Yes
Interface	USB2.0, RJ45

Optional Function

HDMI Interface	Optional HDMI interface
4G Module	Optional 4G module
RFID Reader	Optional IC card reader / HID card reader
Fingerprint Module	Optional FBI certified FAP10 capacitive fingerprint sensor
QR Code	Support
Palm Vein	Support
POE	Support

Function Introduction

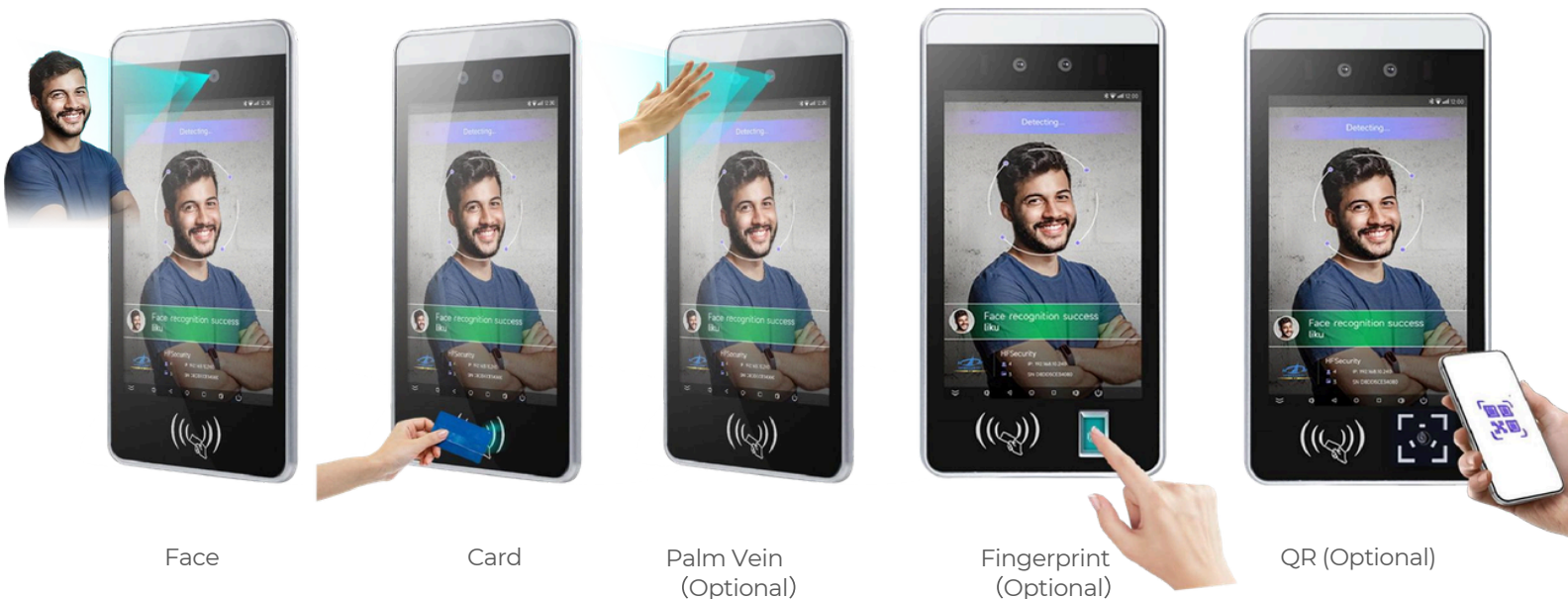

Face

Card

Palm Vein
(Optional)

Fingerprint
(Optional)

QR (Optional)



Turnstile type



Floor stand



Adjustable stand



Desktop type



Wall mounted

Connector Description

GA Version

Wiegand input	Wiegand output
D0-IN	D0-OUT
D1-IN	D1-OUT
12V	GND
GND	

232 serial port	Relay
RX	- → COM1
TX	+ → NO1
GND	

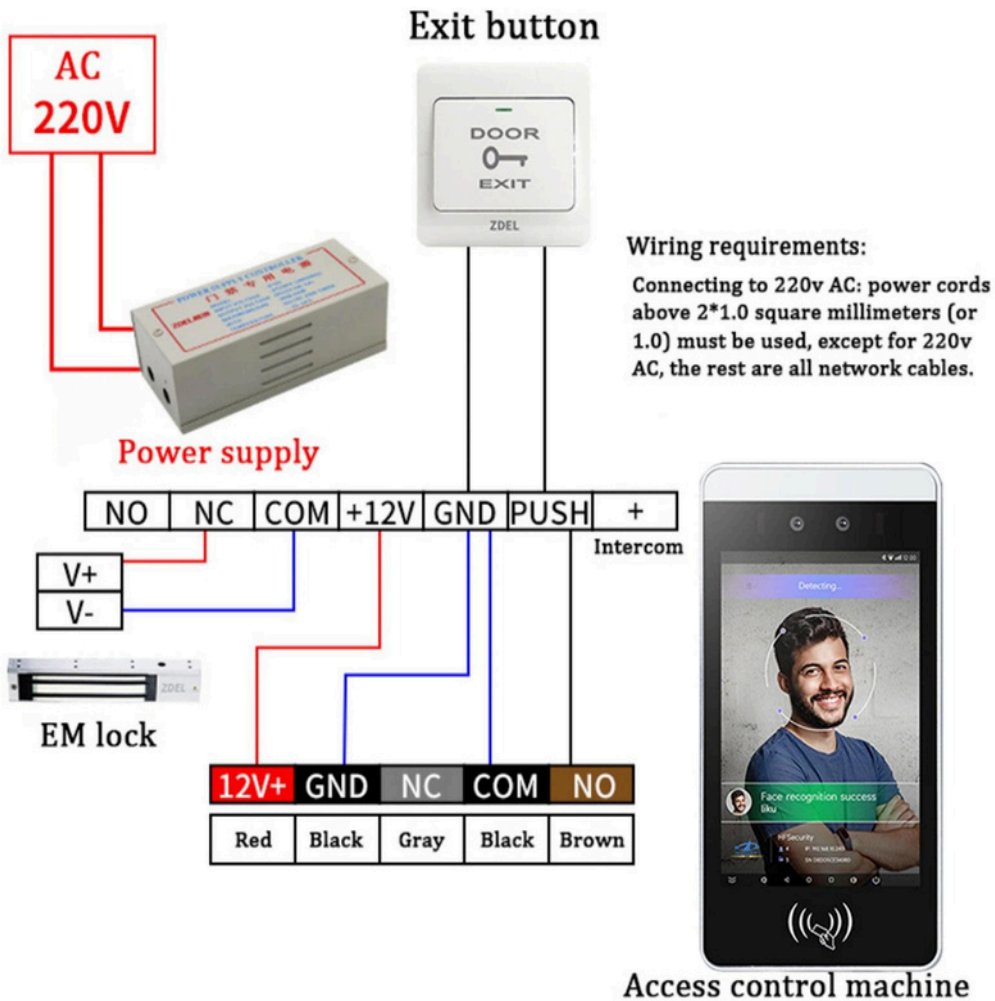
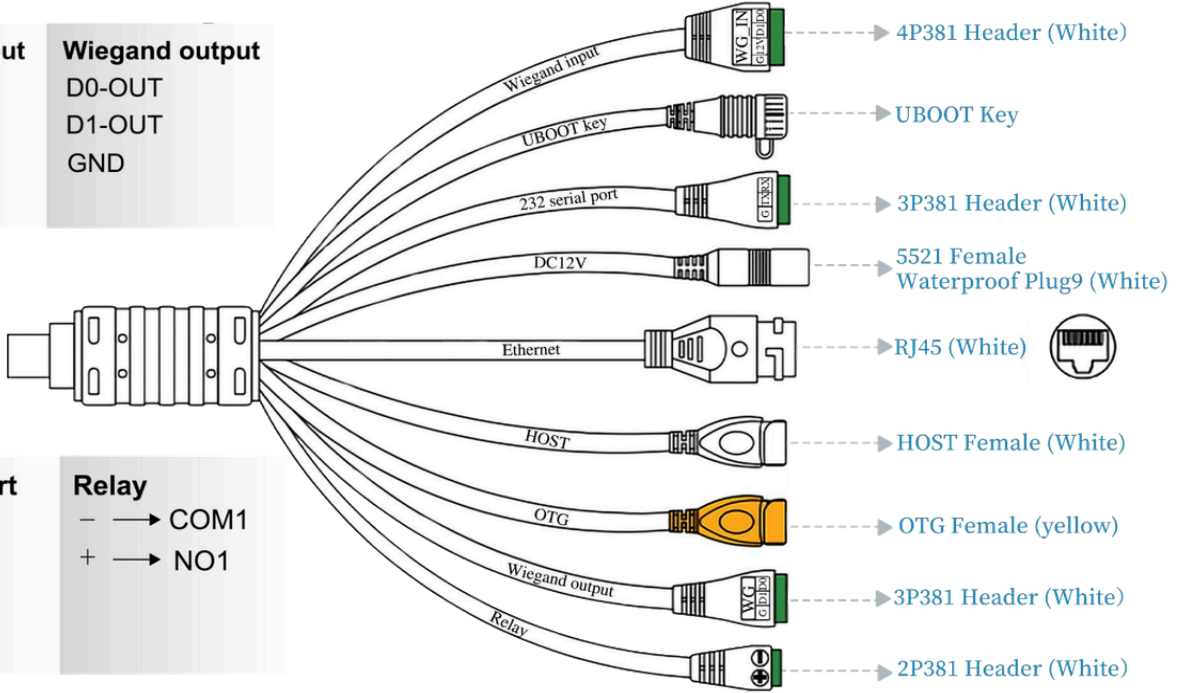

Even One Sample You Can Get

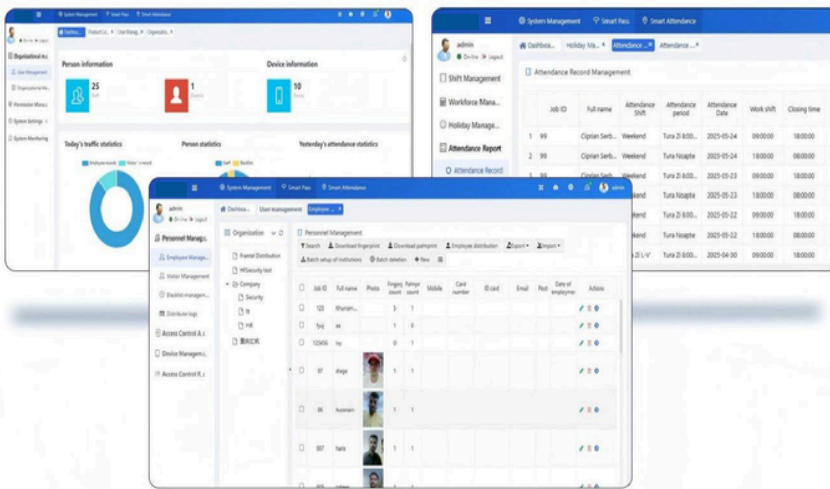

Free Cloud Software



Free API Service



Overall DCNIMS Solution



Register once, use anywhere



- Employee Management
- Visitor Management
- Blacklist Management
- Attendance Record
- Passage Records
- Capture Records
- Attendance Settings
- Ad Settings



Connect with Turnstile Gate



DCNIMS

More turnstiles you can choose

Entrance Control



Remote Attendance Solution

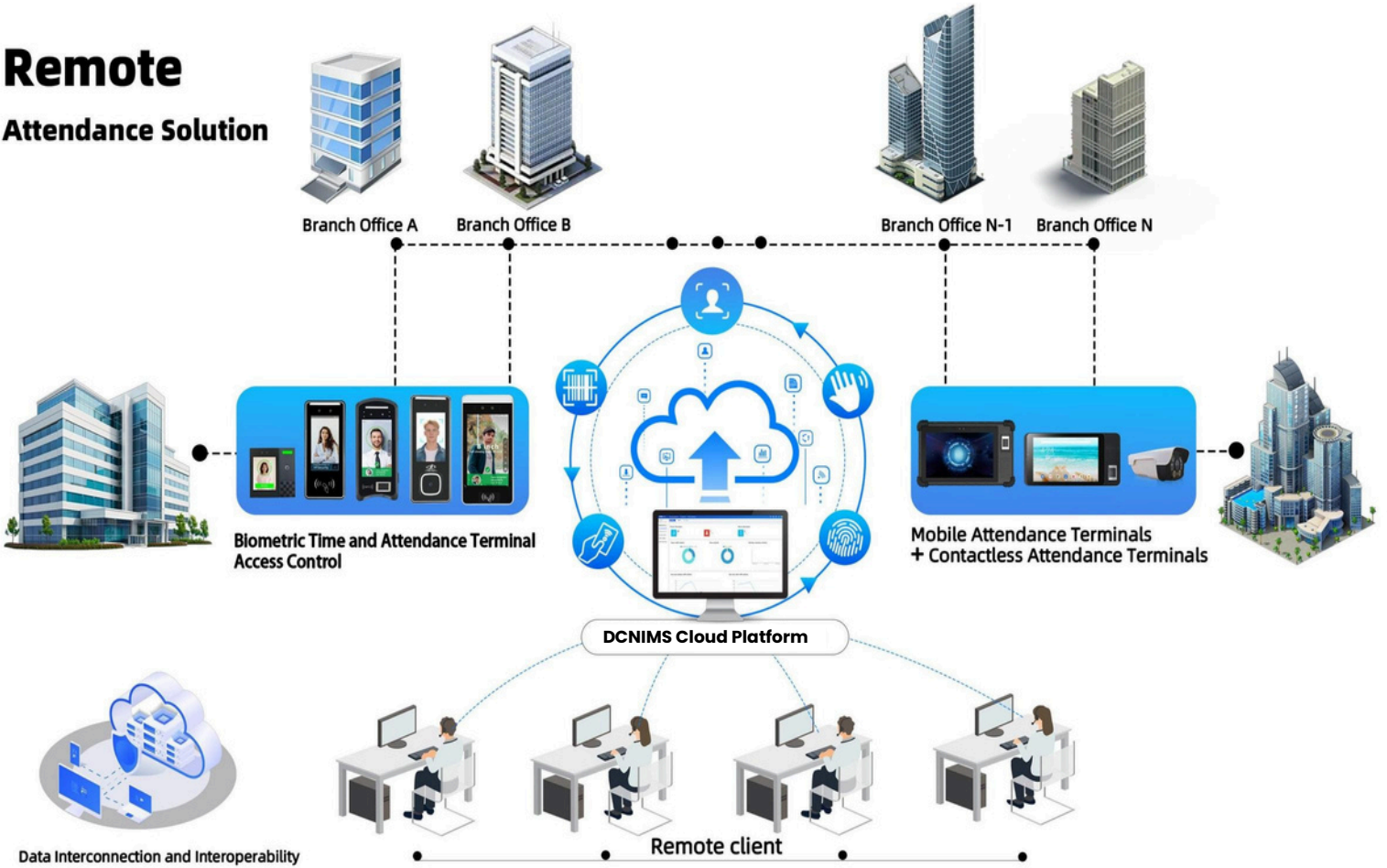

Multi-device connectivity Cross-regional management

Multiple attendance machines interconnected, data centrally managed by headquarters, remote administration of attendance terminals, multi-site data, real-time sharing: **multi-location, multi-store, remote site, location-based attendance management.**

With DCNIMS Cloud Platform

Register Once, Use Anywhere

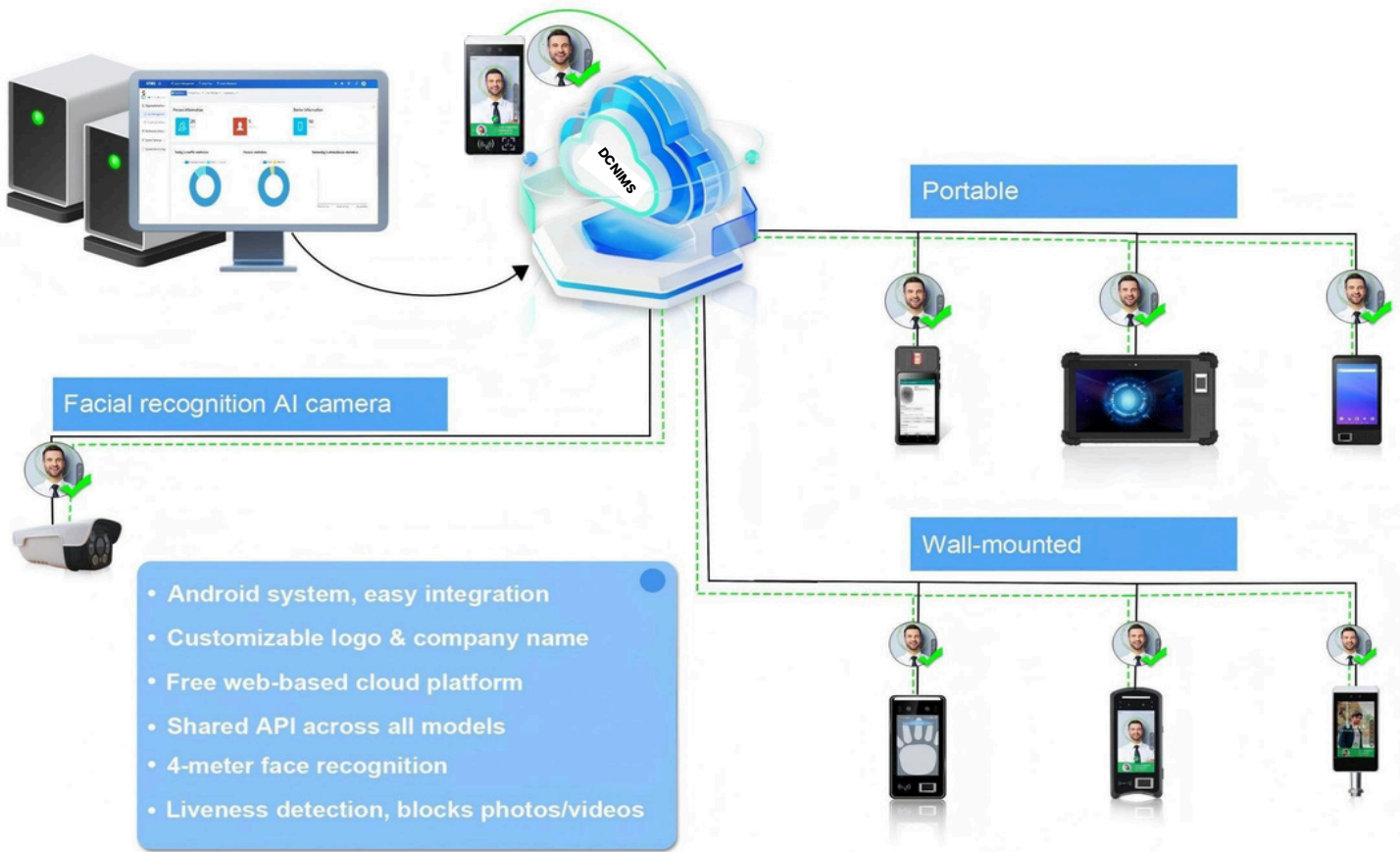

Other Devices You Can Choose

FACE RECOGNITION SERIES



Gym Solution

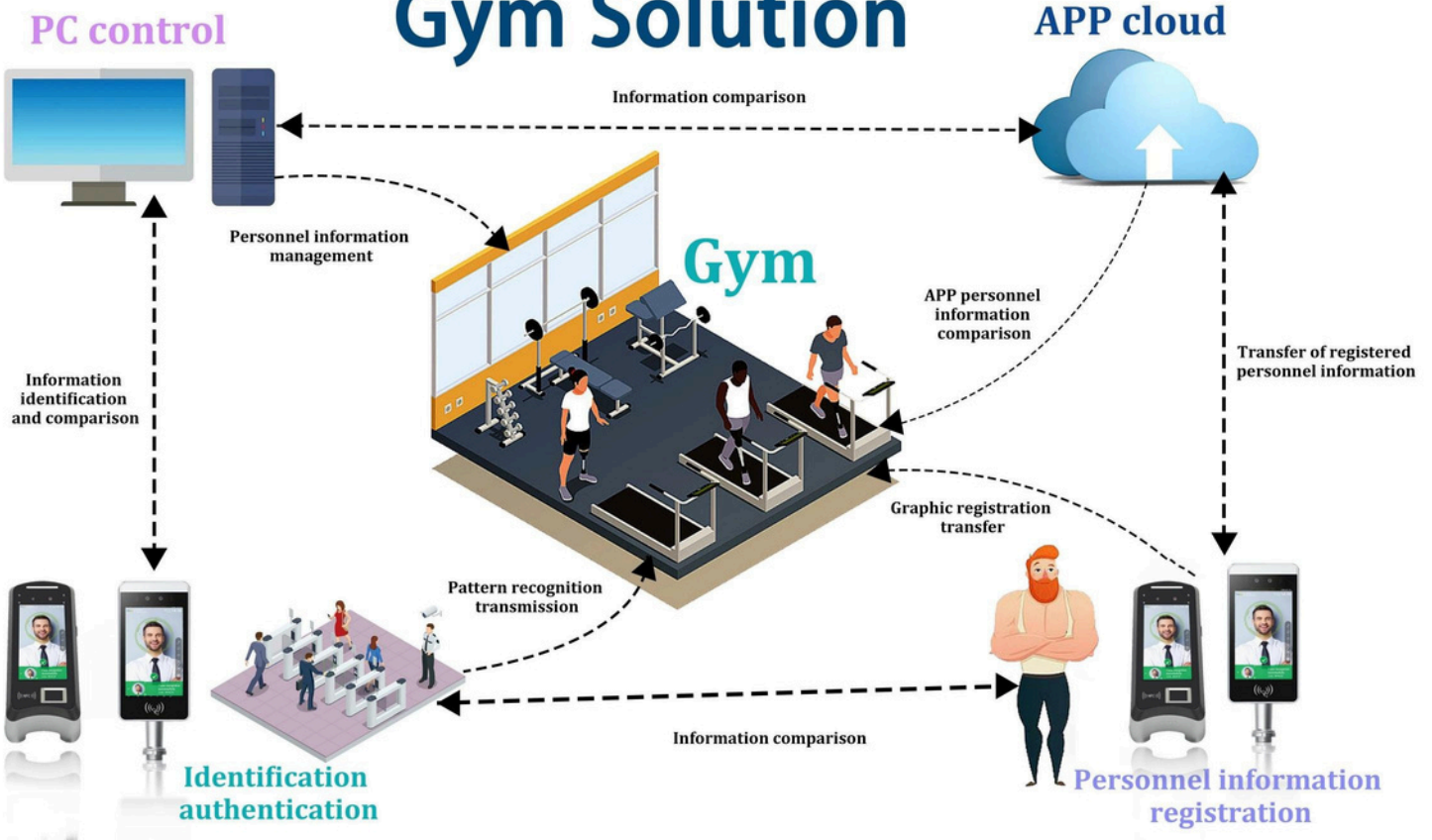

TA & AC Solution

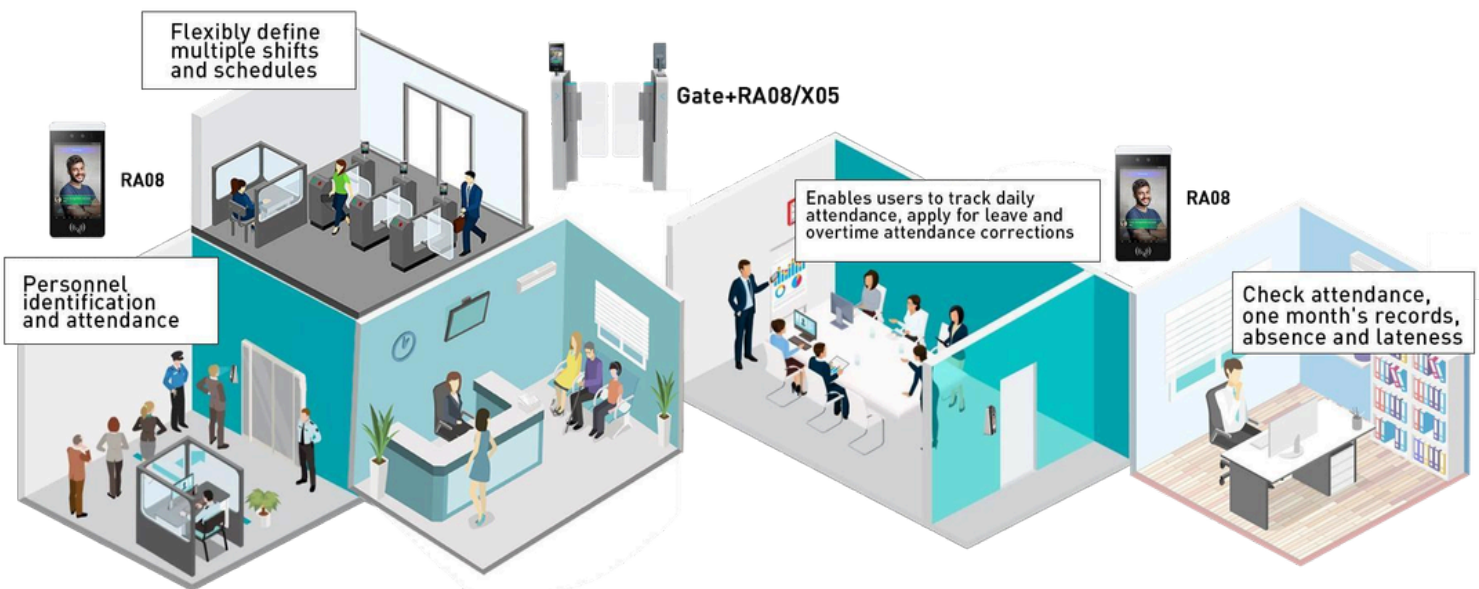

All-in-one Cloud Platform

